

# ORDERING GUIDE

**START** by planning & sketching your railing installation. Follow these steps to determine your material list.

## 1. PICK A POST, SLEEVE, OR WRAP

If your installation has no existing posts, Endurance, Titan Pro, and Excalibur systems have multiple options to choose from. If there are existing posts, choose from our sleeves or wraps.

## 2. PICK YOUR ACCESSORIES

Choose from multiple styles of post caps, trim rings, or lighted accessories.

## 3. PICK YOUR RAIL KIT

Select Endurance Original, Deck or Porch Rail, Titan Pro Rail, or Excalibur level kits up to 10ft. or stair kits up to 8ft. in length.

For Endurance stair kits, refer to the Stair Kit Angle Guide on the following page.

## 4. PICK YOUR BRACKET KITS

Select from a variety of brackets & adapters to simplify any installation.

Note: Endurance kits include brackets necessary for standard installation. Titan Pro and Excalibur posts include pre-attached level brackets. Titan Pro and Excalibur rail kits do not include brackets.

## 5. PICK A GATE KIT (OPTIONAL)

If you need additional safety or security for children and pets Endurance, Titan Pro, and Excalibur systems offer standard and custom gate options.

## 6. SECONDARY HAND RAIL (OPTIONAL)

Endurance Hand Rail provides added safety to stairs or ramps. Please check your local building codes for requirements in your area.

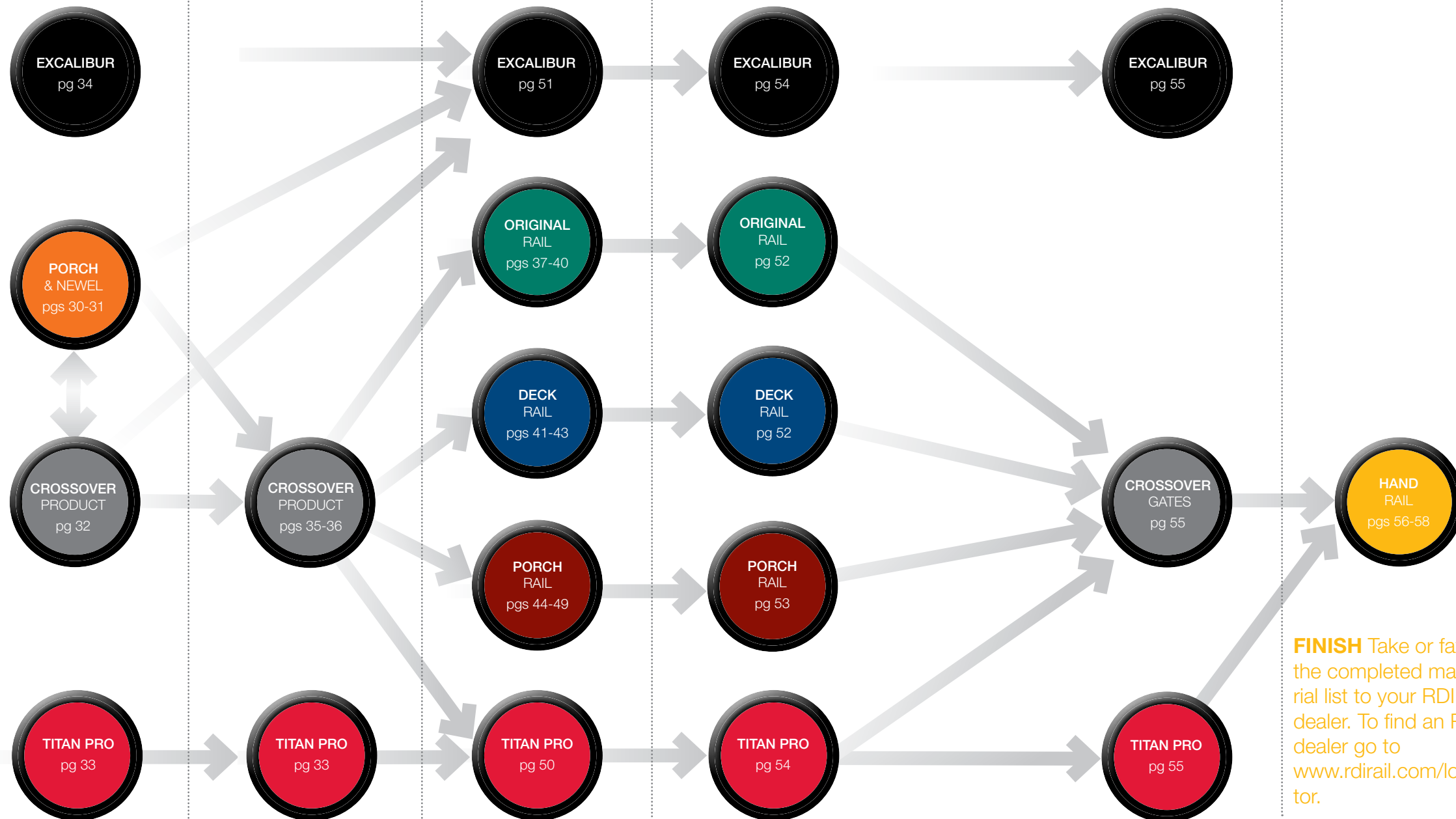

**FINISH** Take or fax the completed material list to your RDI dealer. To find an RDI dealer go to [www.rdirail.com/locator](http://www.rdirail.com/locator).

# STAIR KIT ANGLE GUIDE

		RUN IN INCHES								
		9.0	9.5	10.0	10.5	11.0	11.5	12.0	12.5	13.0
RISE IN INCHES	6.0	34	32	31	30	29	28	27	26	25
	6.5	36	34	33	32	31	29	28	27	27
	7.0	38	36	35	34	32	31	30	29	28
	7.5	40	38	37	36	34	33	32	31	30
	8.0	42	40	39	37	36	35	34	33	32
	8.5	43	42	40	39	38	36	35	34	33

For Endurance kits: use a 36°-41° stair kit

For Endurance kits: use a 29°-35° stair kit

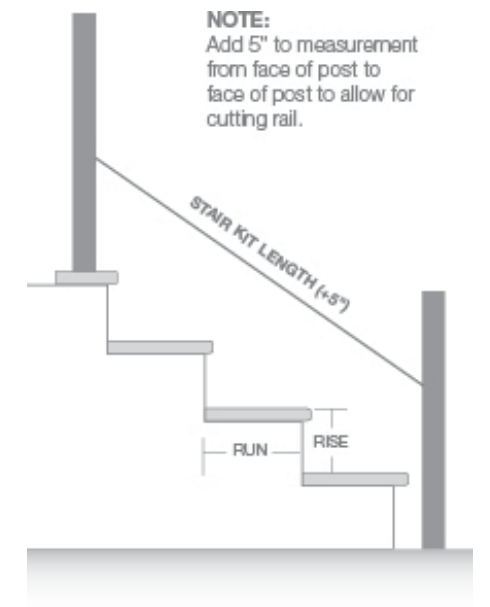

Note: The Stair Kit Angle Guide is used with RDI Endurance Rail only.

# STEP 1 - PICK A POST, SLEEVE, OR WRAP STRUCTURAL POST OPTIONS

Our internal structural posts are designed for almost any type of installation whether it be a flush mount, thru-deck, fascia, or masonry core mount application. All posts are hot-dipped, galvanized steel and provide structure, while the innovative vinyl extrusion centers and supports the vinyl sleeve or newel. The finned extrusion provides embedment for bracket screws, and transfers the load placed on the railing back to the structure below the deck surface. Newel and square post sleeves (pg. 32) are sold separately from the structural posts.

PSP36F - 36" Structural Post  
PSP42F - 42" Structural Post

PSP36T - 36" Structural Post  
PSP42T - 42" Structural Post

PSP36T - 36" Structural Post  
PSP42T - 42" Structural Post

PSP36T - 36" Structural Post  
PSP42T - 42" Structural Post

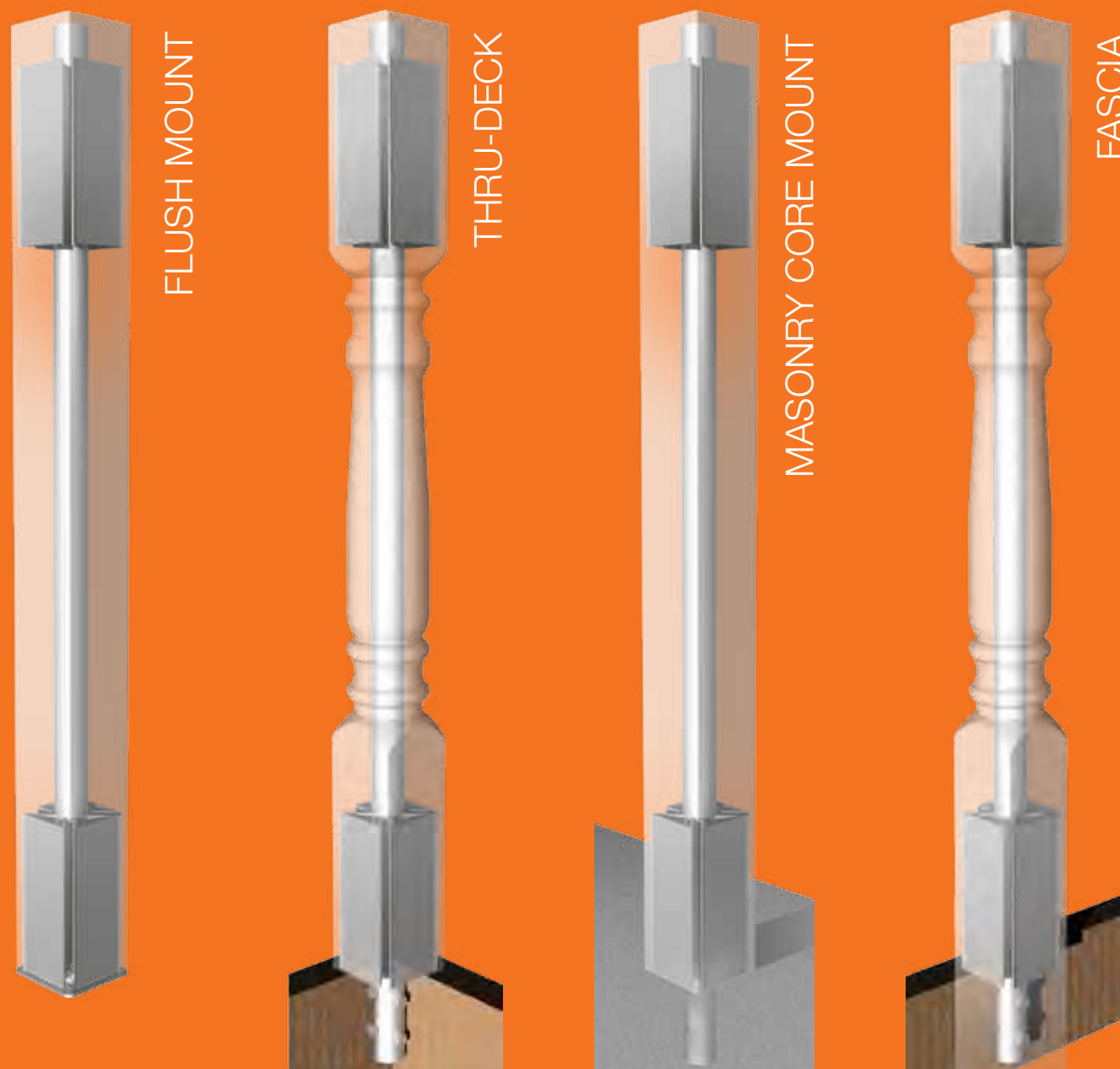

# STEP 1 - PICK A POST, SLEEVE, OR WRAP PORCH POST OPTIONS & BASE KITS

PORCH POST designs capture the elegant style of a turned, painted wood post or a clean, sleek traditional square design without the maintenance. Inside the Porch Posts are load-bearing aluminum columns with load capacities up to 8,500 lbs.

Our BASE KITS kits are available in two styles: a Standard Base Kit and a Wind Uplift Base Kit. Both kits are available in 4" and 5" sizes and come complete with top and bottom base plates and gaskets.\* The Wind Uplift Base Kit utilizes a one-of-a-kind Hurricane Piston Lock that prevents wind uplift (up to 2,800 lbs.) and eliminates roof jacking during installation.

## STANDARD BASE KITS

EAPB4L - 4 Inch  
EAPB5L - 5 Inch

## WIND UPLIFT BASE KITS

EAPB4H - 4 Inch  
EAPB5H - 5 Inch

## SQUARE POST

PVA425W - 4 Inch Post - 2500 lb.

## TURNED POSTS

PVB425W - 4 Inch Post - 2500 lb.  
PVB550W - 5 Inch Post - 5000 lb.  
PVB585W - 5 Inch Post - 8500 lb.

STANDARD BASE KIT

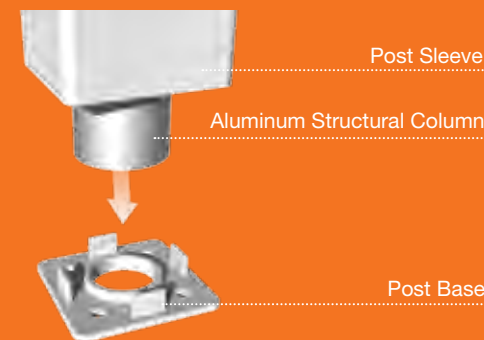

WIND UPLIFT BASE KIT\*\*

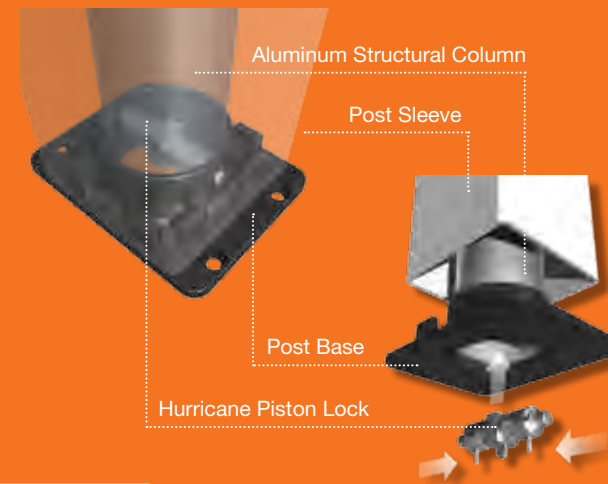

\*The PVC gasket prevents corrosion of the base plate and accommodates all Base Kits.

\*\*The Wind Uplift Kit Base is shown in black for illustration purposes only.



The adjustable Elite 4-Piece Trim Ring† (EATRU) can be installed at any time and can be adjusted to fit posts from 3½" x 3½" to 6½" x 6½" without nails, screws or glue.

† Required for Wind Uplift Base Kit.

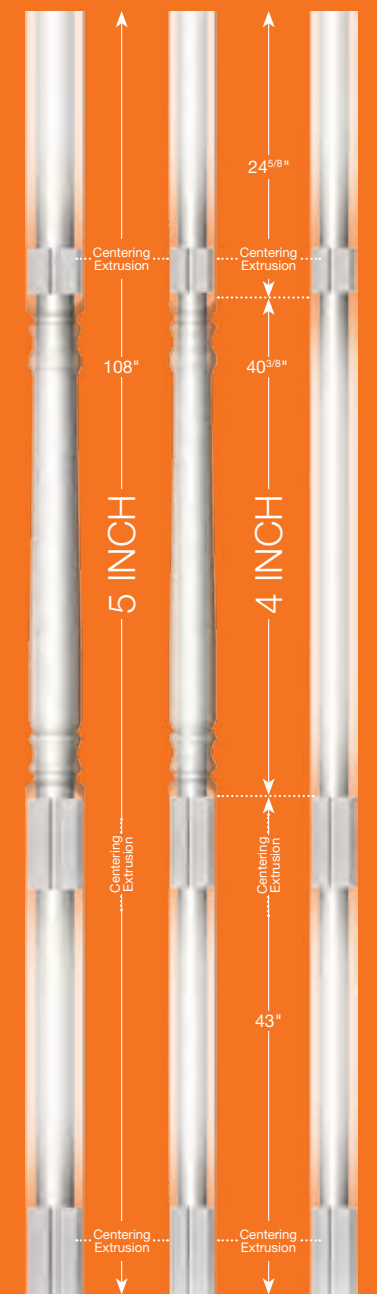

# STEP 1 - PICK A POST, SLEEVE, OR WRAP

## POST SLEEVES

### 4" SQUARE SLEEVE

4" x 4" square vinyl sleeves slide easily over Endurance structural posts, wood newels and load-bearing posts.

Actual product dimensions are external measurements. 4" x 4" post sleeves fit over wood 4" x 4" posts (3½" x 3½").

#### BAGGED SQUARE SLEEVES

VPS039W - 4" x 39"

VPS045W - 4" x 45"

VPS108W - 4" x 108"

#### BOXED SQUARE SLEEVES

EAPS54 - 4" x 54"

EAPS108 - 4" x 108"

### 6" SQUARE SLEEVE

6" x 6" square vinyl sleeves slide easily over wood newels and load-bearing posts.

Actual product dimensions are external measurements. 6" x 6" sleeves fit over wood 6" x 6" posts (5½" x 5½").

#### BOXED SQUARE SLEEVES

EAPS654 - 6" x 54"

EAPS608 - 6" x 108"

### 4" TURNED SLEEVE

4" x 4" turned vinyl sleeves slide easily over Endurance structural posts.

#### BOXED TURNED SLEEVE

PVBN48W - 4" x 48"

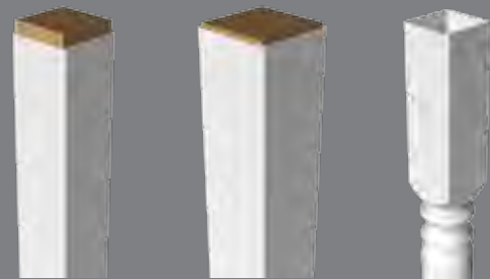

4x4" Square

6x6" Square

4x4" Turned

## POST WRAPS

POST WRAPS install quickly and easily to cover a new or existing post. Use over porch posts, newel posts, deck supports, square lamp posts, mail box posts, and old painted posts. To install, simply cut to length and snap in place; the 4 pieces adjust to fit warped or twisted posts with no fasteners or adhesives needed. Flat or Fluted styles are available in 2 sizes to fit over 4"x4" or 6"x6" posts.

#### FLAT WRAP

EAPW308 - 4" x 96"

EAPW310 - 4" x 120"

EAPW508 - 6" x 96"

EAPW510 - 6" x 120"

#### FLUTED WRAP

EAPWF408 - 4" x 96"

EAPWF410 - 4" x 120"

EAPWF608 - 6" x 96"

EAPWF610 - 6" x 120"

#### SIZING GUIDE:

4" x 4" Flat and Fluted Wraps fit over posts from 3 3/8" to 4 1/8"

6" x 6" Flat and Fluted Wraps fit over posts from 5 7/16" to 6 1/8"

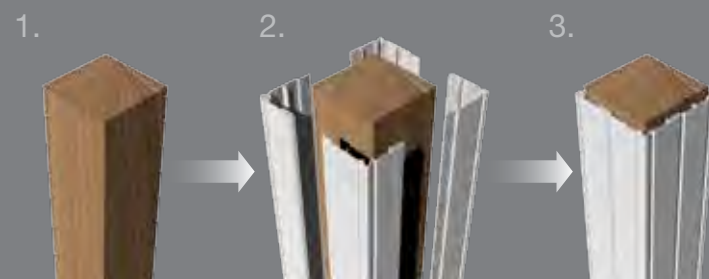

Post Wraps are covered by US patent number D521,656S.

# STEP 1 & 2 - PICK A POST

## TITAN POST OPTIONS

Titan Pro End, Mid, and Corner posts are supplied pre-assembled for 36" or 42" high railing applications and include the vinyl sleeve, galvanized structural post, pre-attached level brackets\*, flexible bracket covers, and 2-piece trim ring (Post Caps sold separately. See below). The blank post can be utilized in both stair and level applications if the pre-assembled post is not ideal.

TPPE36 - 36" End Post  
TPPE42 - 42" End Post

TPPL36 - 36" Mid Post  
TPPL42 - 42" Mid Post

TPPC36 - 36" Corner Post  
TPPC42 - 42" Corner Post

TPPB36 - 36" Blank Post  
TPPB42 - 42" Blank Post  
TPPB48 - 48" Blank Post



\*Note: Titan Pro posts include pre-attached level brackets. Titan Pro rail kits do not include brackets.

TPADC - DECORATIVE CAP



TPAFC - FLAT CAP



For permanent attachment of caps, Christie's Red Hot White Vinyl Adhesive (RH-F-W15) is recommended, available through your RDI Dealer.

# STEP 1 & 2 - PICK A POST

## EXCALIBUR POST OPTIONS

Excalibur End, Mid, and Corner posts are supplied pre-assembled for applications with either a 2 inch or 4 inch bottom space. Each post includes pre-attached level brackets,\* 2- piece trim ring, and post cap. The blank post can be utilized in both stair and level applications if the pre-assembled post is not ideal. Blank Posts are available in 5 heights; select the one that best fits your rail height.

MWEPE36B - 36" rail height with a 2" bottom space

MWEPE42B - 42" rail height with a 2" bottom space

MWEPE38B - 38" rail height with a 4" bottom space

MWEPE44B - 44" rail height with a 4" bottom space

MWEPL36B - 36" rail height with a 2" bottom space

MWEPL42B - 42" rail height with a 2" bottom space

MWEPL38B - 38" rail height with a 4" bottom space

MWEPL44B - 44" rail height with a 4" bottom space

MWEPC36B - 36" rail height with a 2" bottom space

MWEPC42B - 42" rail height with a 2" bottom space

MWEPC38B - 38" rail height with a 4" bottom space

MWEPC44B - 44" rail height with a 4" bottom space

MWEPB36B - 36" blank post

MWEPB38B - 38" blank post

MWEPB42B - 42" blank post

MWEPB44B - 44" blank post

MWEPB48B - 48" blank post



Factory matched touch-up paint (MWETPB) is available through your RDI Dealer.

\*Note: Excalibur Blank posts do not include brackets.

# STEP 2 - PICK YOUR ACCESSORIES

## POST CAPS and TRIM RINGS

4" ELITE CAP - EALC4

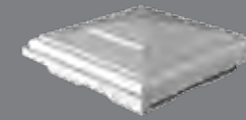

4" NEW ENGLAND CAP - EAEC4

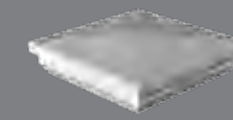

4" BALL CAP - EABC4

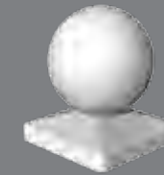

4" FLAT CAP - EAFC4

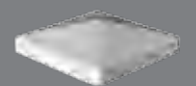

4" NEPTUNE - 1476



4" BRIDGEPORT - 1325



4" HAMPTON - 1326

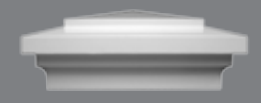

4" PRINCETON - 1431



6" ELITE CAP - EALC6

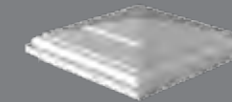

6" NEW ENGLAND CAP - EAEC6

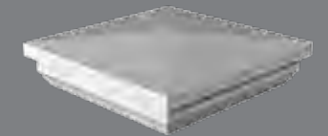

Can be used with Post Wraps if outside dimensions are less than 6<sup>5/16"</sup>

4" ELITE TRIM RING - 1-PIECE - EATRL4



4" LOW PROFILE TRIM RING - 1-PIECE - EATR4LP



4" NEW ENGLAND TRIM RING - 1-PIECE - EATR4

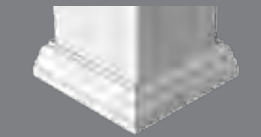

4" ELITE ADJUSTABLE TRIM RING - 4-PIECE - EATRU

The adjustable Elite 4-Piece Trim Ring can be installed at any time and is identical in style to the 1-piece Elite trim ring. It can be adjusted to fit posts from 3½" x 3½" to 6½" x 6½" without nails, screws or glue.

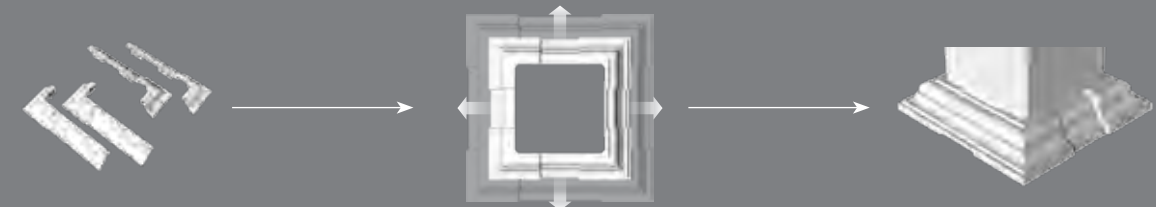

For permanent attachment, Christie's Red Hot White Vinyl Adhesive (RH-F-W15) is recommended, available through your RDI Dealer.

\*The EATRU is covered by US patent number 7,243,473B2.

## STEP 2 - PICK YOUR ACCESSORIES

# LIGHTED ACCESSORIES

4" KINDLE LOW VOLTAGE CAP EAKLV4

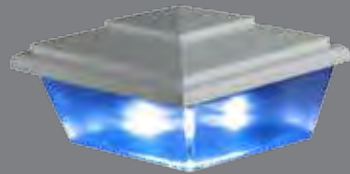

4" KINDLE SOLAR CAP - EAKSC4

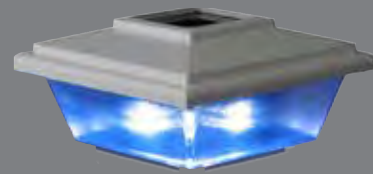

4" NEPTUNE  
LOW VOLTAGE CAP - 1485

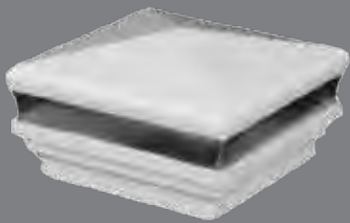

4" NEPTUNE  
SOLAR CAP - 1481



4" CAMBRIDGE SOLAR  
CAP - LZN44

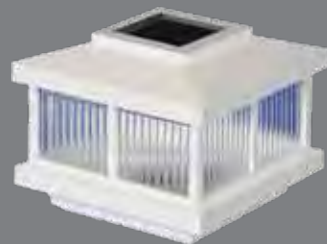

4" CAMBRIDGE LOW  
VOLTAGE CAP - LVN44

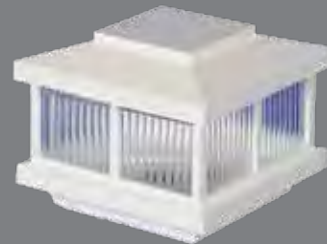

3"x2<sup>3</sup>/<sub>8</sub>"x7" GALAXY  
SOLAR WEDGE -  
1306W



1<sup>7</sup>/<sub>8</sub>"x 4<sup>1</sup>/<sub>5</sub>" x 1<sup>1</sup>/<sub>2</sub>"  
GALAXY SOLAR  
MINI-WEDGE  
1392W - White



1<sup>7</sup>/<sub>8</sub>"x 4<sup>1</sup>/<sub>5</sub>" x 1<sup>1</sup>/<sub>2</sub>"  
GALAXY SOLAR  
MINI-WEDGE  
1392B - Black



1<sup>7</sup>/<sub>8</sub>"x 4<sup>1</sup>/<sub>5</sub>" x 1<sup>1</sup>/<sub>2</sub>"  
GALAXY SOLAR  
MINI-WEDGE  
1392C - Copper



For permanent attachment, Christie's Red Hot White Vinyl Adhesive (RH-F-W15) is recommended, available through your RDI Dealer.

## STEP 3 - PICK A KIT

# ORIGINAL RAIL LEVEL & STAIR KITS

Original Rail level and stair kits contain everything you need to create a safe and code-compliant rail section in one convenient box: top and bottom vinyl extrusions with interior aluminum stiffeners, locking pins, balusters, mounting brackets with integral locking screw covers, and stainless steel mounting screws. Level kits come in 4, 5, 6, 8, and 10ft. lengths; stair kits come in 6 and 8ft. lengths and angles of either 29°-35° or 36°-41° (eliminating cutting or filing baluster holes). All kits are available in your choice of balusters: square, turned, round metal, glass, & belly, as well as glass panel. (See pages 37-39 for details).

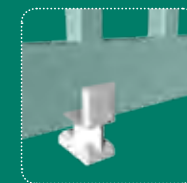

2- PIECE ADJUSTABLE  
LEVEL RAIL SUPPORT  
(EALRS)

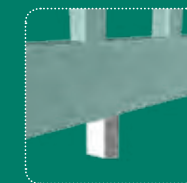

2- PIECE LEVEL RAIL  
SUPPORT, 2" (EASB)

A support foot should be added to rail sections longer than 8' to strengthen the installation.

EALRS two-piece adjustable level rail support may be adjusted on site from 2"-4", sold separately.

EASB two-piece level rail support 2", sold separately and included in some kits.†



If using Endurance Hand Rail (Pg. 55-57) posts must not exceed 6' on center.

Use the Stair Kit Ordering Guide on page 29 to determine the correct stair kit for your installation.

# STEP 3 - PICK A KIT

## KIT OPTIONS

### SQUARE BALUSTER RAIL KITS (Balusters included in kit box.)

LEVEL 36" HEIGHT	STAIR 36" HEIGHT
ENDL4 - 4' lgth.	ENDS629-35 - 6' lgth. - 29°-35°
ENDL5 - 5' lgth.	ENDS636-41 - 6' lgth. - 36°-41°
ENDL6 - 6' lgth.	ENDS829-35 - 8' lgth. - 29°-35°
ENDL8 - 8' lgth.	ENDS836-41 - 8' lgth. - 36°-41°
ENDL10 - 10' lgth.	ENDS62935QX* - 6' lgth - 29°-35°
ENDL4QX† - 4' lgth	ENDS63641QX* - 6' lgth - 36°-41°
ENDL5QX† - 5' lgth.	ENDS82935QX* - 8' lgth - 29°-35°
ENDL6QX† - 6' lgth	ENDS83641QX* - 8' lgth - 36°-41°
ENDL8QX† - 8' lgth.	

LEVEL 42" HEIGHT	STAIR 42" HEIGHT
ENDL4-42 - 4' lgth.	ENDS629-42 - 6' lgth. - 29°-35°
ENDL5-42 - 5' lgth.	ENDS636-42 - 6' lgth. - 36°-41°
ENDL6-42 - 6' lgth.	ENDS829-42 - 8' lgth. - 29°-35°
ENDL8-42 - 8' lgth.	ENDS836-42 - 8' lgth. - 36°-41°
ENDL10-42 - 10' lgth.	



### TURNED BALUSTER RAIL KITS (Balusters included in kit box.)

LEVEL 36" HEIGHT	STAIR 36" HEIGHT
ENDTL4 - 4' lgth.	ENDTS629-35 - 6' lgth. - 29°-35°
ENDTL5 - 5' lgth.	ENDTS636-41 - 6' lgth. - 36°-41°
ENDTL6 - 6' lgth.	ENDTS829-35 - 8' lgth. - 29°-35°
ENDTL8 - 8' lgth.	ENDTS836-41 - 8' lgth. - 36°-41°
ENDTL10 - 10' lgth.	

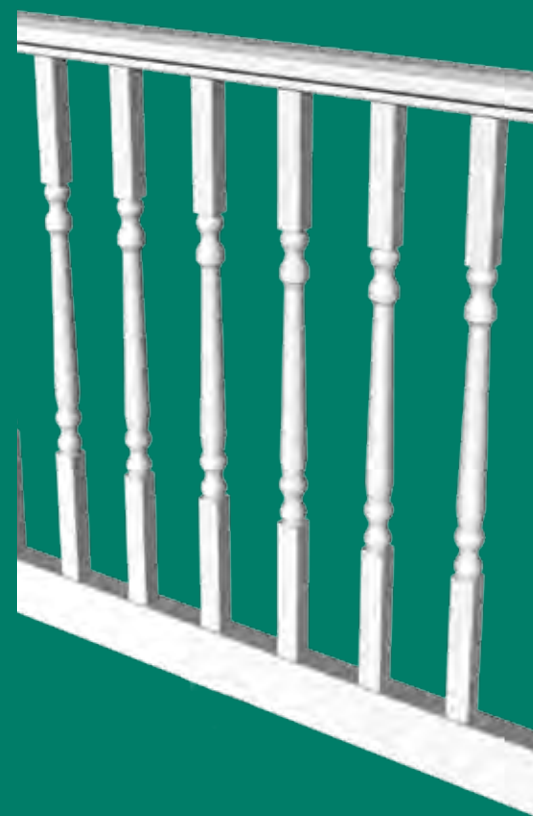

\*Aluminum Stiffener is not included in the bottom rail of QX railing kits.

†Includes EASB Level Rail Support.

# STEP 3 - PICK A KIT

## KIT OPTIONS

### ROUND METAL BALUSTER RAIL KITS (Balusters included in kit box.)

LEVEL 36" HEIGHT	STAIR 36" HEIGHT
ENDRL4 - 4' lgth.	ENDRS62935 - 6' lgth. - 29°-35°
ENDRL5 - 5' lgth.	ENDRS63641 - 6' lgth. - 36°-41°
ENDRL6 - 6' lgth.	ENDRS82935 - 8' lgth. - 29°-35°
ENDRL8 - 8' lgth.	ENDRS83641 - 8' lgth. - 36°-41°
ENDRL10 - 10' lgth.	

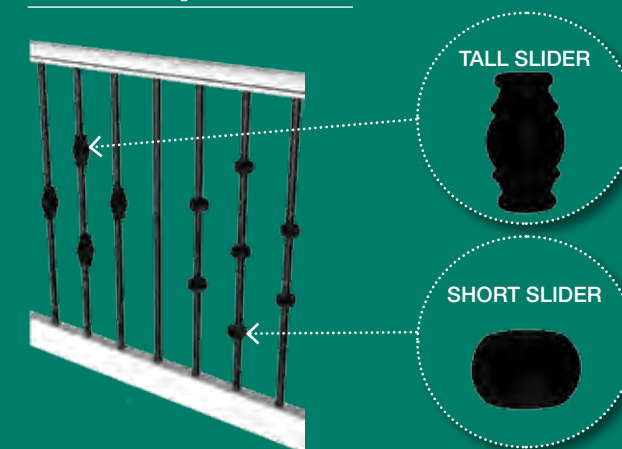

### ROUND METAL BALUSTER RAIL KITS (Balusters NOT included. See below for quantity requirements for each kit.)

LEVEL 36" HEIGHT	STAIR 36" HEIGHT
ENDL4RD - 4' lgth.	ENDS62935RD - 6' lgth. - 29°-35°
ENDL5RD - 5' lgth.	ENDS63641RD - 6' lgth. - 36°-41°
ENDL6RD - 6' lgth.	ENDS82935RD - 8' lgth. - 29°-35°
ENDL8RD - 8' lgth.	ENDS83641RD - 8' lgth. - 36°-41°
ENDRL10 - 10' lgth.	

For Level Kits:

Kit Length	# Balusters
4 ft	10
5 ft	13
6 ft	15
8 ft	21
10 ft	26

For Stair Kits:

Kit Length	# Balusters
6 ft 29°-35°	14
6 ft 36°-41°	13
8 ft 29°-35°	19
8 ft 36°-41°	18

### ROUND METAL BALUSTER - 10 Per Box

MWAB32B - Aluminum Baluster - Black

### SLIDERS - 4 Per Set

MWAS3402B - Short Aluminum Slider - Black

MWAS3406B - Tall Aluminum Slider - Black

### GLASS BALUSTER RAIL KITS (Balusters not included in kit box.)

LEVEL KITS	STAIR KITS
ENDL4GS† - 4' lgth.	ENDS62935GS - 6' lgth. - 29°-35°
ENDL5GS† - 5' lgth.	ENDS63641GS - 6' lgth. - 36°-41°
ENDL6GS† - 6' lgth.	ENDS82935GS - 8' lgth. - 29°-35°
ENDL8GS† - 8' lgth.	ENDS83641GS - 8' lgth. - 36°-41°
ENDL10GS† - 10' lgth.	

### GLASS BALUSTERS

ENDGBL - Glass Baluster Level - 5 per box

ENDGBS - Glass Baluster Stair - 5 per box

### NOTE:

When ordering Glass Baluster Kits, balusters are ordered separately. If using ENDGBL (above) your finished rail height will be 38". See below for baluster quantity requirements by kit length:

For Level Kits:

Kit Length	# Balusters
4 ft	6
5 ft	8
6 ft	9
8 ft	12
10 ft	15

For Stair Kits:

Kit Length	# Balusters
6 ft 29°-35°	7
6 ft 36°-41°	7
8 ft 29°-35°	10
8 ft 36°-41°	9

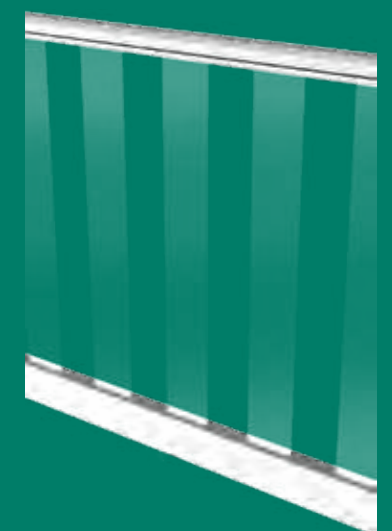

†Includes EASB Level Rail Support.

# STEP 3 - PICK A KIT

## KIT OPTIONS

### GLASS PANEL RAIL KITS

Glass Panels are not supplied by Railing Dynamics. Rail kits include all components necessary for a complete railing section except for the glass panel. Please specify glass thickness when ordering.

#### LEVEL 36" HEIGHT

ENDL4PG† - 4' lgth. White

ENDL5PG† - 5' lgth. White

ENDL6PG† - 6' lgth. White

### BELLY BALUSTER RAIL KITS - WHITE ONLY (Balusters not included in kit box.)

#### LEVEL 36" HEIGHT

ENDL4BY - 4' lgth.

ENDL5BY - 5' lgth.

ENDL6BY - 6' lgth.

ENDL8BY - 8' lgth.

ENDL10BY - 10' lgth.

#### STAIR 36" HEIGHT

ENDS62935BY - 6' lgth. - 29°-35°

ENDS63641BY - 6' lgth. - 36°-41°

ENDS82935BY - 8' lgth. - 29°-35°

ENDS83641BY - 8' lgth. - 36°-41°

#### BELLY BALUSTERS - 10 Per Box

ENDBBW - Belly Baluster

#### NOTE:

When ordering Belly Baluster Kits, balusters are ordered separately. Balusters are packaged 10 per box. See below for baluster requirements based on kit length:

#### For Level Kits:

Kit Length	# Balusters
4 ft	9
5 ft	11
6 ft	13
8 ft	18
10 ft	22

#### For Stair Kits:

Kit Length	# Balusters
6 ft 29°-35°	11
6 ft 36°-41°	10
8 ft 29°-35°	14
8 ft 36°-41°	13



†Includes EASB Level Rail Support.

# STEP 3 - PICK A KIT

## DECK RAIL LEVEL & STAIR KITS

Deck Rail level and stair kits contain everything you need to create a safe and code-compliant rail section in one convenient box: top and bottom vinyl extrusions with interior aluminum stiffeners, balusters, locking screws, mounting brackets with integral locking screw cover caps, and stainless steel mounting screws. Level kits come in 5, 6, 8, and 10ft. lengths; stair kits come in 6 and 8ft. lengths and angles of either 29°-35° or 36°-41° (eliminating cutting or filling baluster holes). All kits are available in your choice of balusters: square, turned, round Metal, glass, & belly. (See pages 41-42 for details).



If using Endurance Hand Rail (Pg. 55-57) posts must not exceed 6' on center.

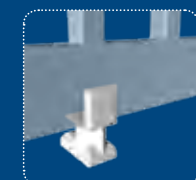

2-PIECE ADJUSTABLE LEVEL RAIL SUPPORT (EALRS)

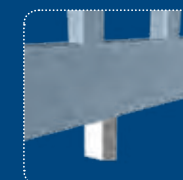

2-PIECE LEVEL RAIL SUPPORT, 2" (EASB)

A support foot should be added to rail sections longer than 8' to strengthen the installation.

EALRS two-piece adjustable level rail support may be adjusted on site from 2"-4", sold separately.

EASB two-piece level rail support 2", sold separately and included in some kits.†

#### OPTIONAL DECORATIVE CAP

This wide surface provides a great place for plates and drinks while relaxing or entertaining on your deck. The decorative cap is sold separately in 7, 9, and 16ft. lengths and can be installed by simply gluing it down to the top rail. The cap can be used in over-the-post (below left) and post-to post (below right) applications. For permanent attachment, Christie's Red Hot White Vinyl Adhesive is recommended.

EDACR7	7' Decorative Cap
EDACR9	9' Decorative Cap
EDACR16	16' Decorative Cap
EDACEC	Decorative End Cap-Set of 2
RH-F-W15	Christie's Vinyl Adhesive



Use the Stair Kit Ordering Guide on page 29 to determine the correct stair kit for your installation.

# STEP 3 - PICK A KIT

## KIT OPTIONS

### SQUARE BALUSTER RAIL KITS (Balusters included in kit box.)

LEVEL 36" HEIGHT	STAIR 36" HEIGHT
EDRL5 - 5' lgth.	EDRS62935 - 6' lgth. - 29°-35°
EDRL6 - 6' lgth.	EDRS63641 - 6' lgth. - 36°-41°
EDRL8 - 8' lgth.	EDRS82935 - 8' lgth. - 29°-35°
EDRL10 - 10' lgth.	EDRS83641 - 8' lgth. - 36°-41°



### TURNED BALUSTER RAIL KITS (Balusters included in kit box.)

LEVEL 36" HEIGHT	STAIR 36" HEIGHT
EDRTL5 - 5' lgth.	EDRTS62935 - 6' lgth. - 29°-35°
EDRTL6 - 6' lgth.	EDRTS63641 - 6' lgth. - 36°-41°
EDRTL8 - 8' lgth.	EDRTS82935 - 8' lgth. - 29°-35°
EDRTL10 - 10' lgth.	EDRTS83641 - 8' lgth. - 36°-41°

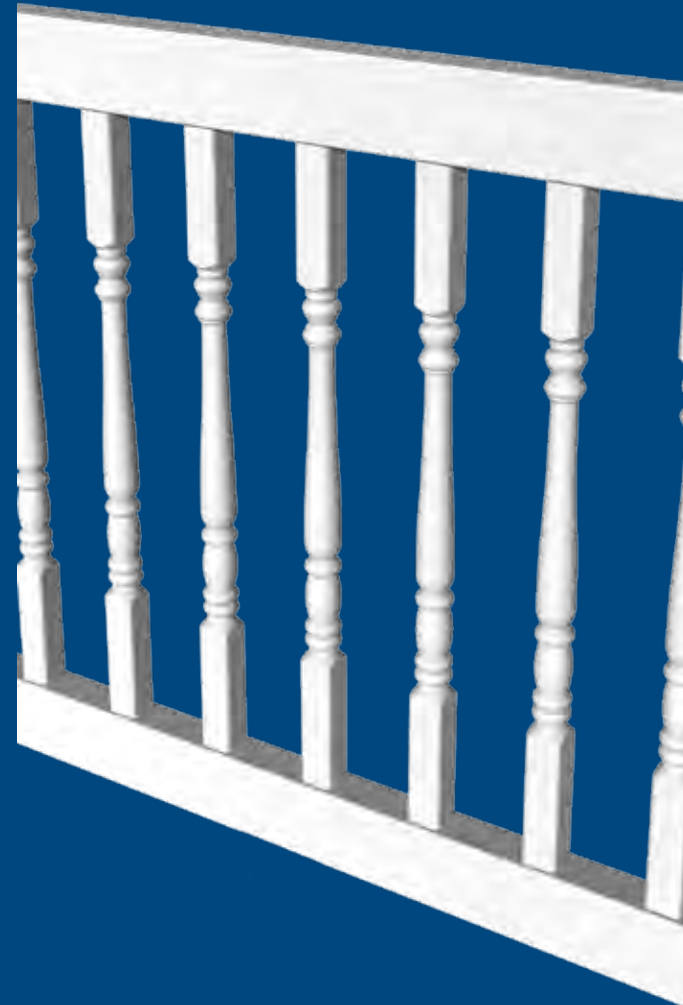

# STEP 3 - PICK A KIT

## KIT OPTIONS

### ROUND METAL BALUSTER RAIL KITS (Balusters included in kit box.)

LEVEL 36" HEIGHT	STAIR 36" HEIGHT
EDRRL5 - 5' lgth.	EDRRS62935 - 6' lgth. - 29°-35°
EDRRL6 - 6' lgth.	EDRRS63641 - 6' lgth. - 36°-41°
EDRRL8 - 8' lgth.	EDRRS82935 - 8' lgth. - 29°-35°
EDRRL10 - 10' lgth.	EDRRS83641 - 8' lgth. - 36°-41°

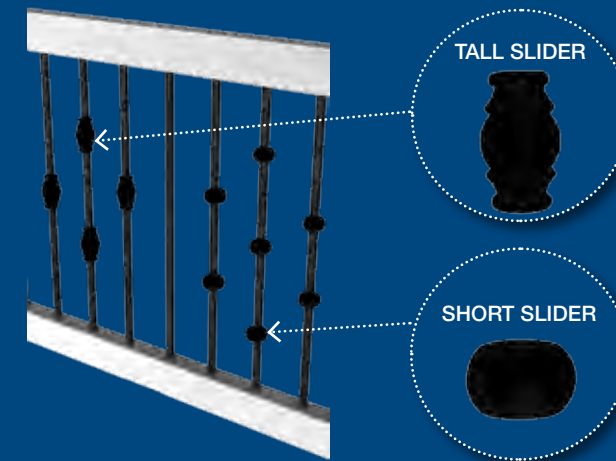

### ROUND METAL BALUSTER RAIL KITS (Balusters NOT included. See below for quantity requirements for each kit.)

LEVEL 36" HEIGHT	STAIR 36" HEIGHT
EDRL4RD - 4' lgth.	EDRS62935RD - 6' lgth. - 29°-35°
EDRL5RD - 5' lgth.	EDRS63641RD - 6' lgth. - 36°-41°
EDRL6RD - 6' lgth.	EDRS82935RD - 8' lgth. - 29°-35°
EDRL8RD - 8' lgth.	EDRS83641RD - 8' lgth. - 36°-41°
EDRL10RD - 10' lgth.	

#### For Level Kits:

Kit Length	# Balusters
4 ft	10
5 ft	13
6 ft	15
8 ft	21
10 ft	26

#### For Stair Kits:

Kit Length	# Balusters
6 ft 29°-35°	14
6 ft 36°-41°	13
8 ft 29°-35°	19
8 ft 36°-41°	18

#### ROUND METAL BALUSTER - 10 Per Box

MWAB32B - Aluminum Baluster - Black

#### SLIDERS - 4 Per Set

MWAS3402B - Short Aluminum Slider - Black

MWAS3406B - Tall Aluminum Slider - Black

### GLASS BALUSTER RAIL KITS (Balusters not included in kit box.)

LEVEL KITS	STAIR KITS
EDRL5GS† - 5' lgth.	EDRS62935GS - 6' lgth. - 29°-35°
EDRL6GS† - 6' lgth.	EDRS63641GS - 6' lgth. - 36°-41°
EDRL8GS† - 8' lgth.	EDRS82935GS - 8' lgth. - 29°-35°
EDRL10GS† - 10' lgth.	EDRS83641GS - 8' lgth. - 36°-41°

#### GLASS BALUSTERS

ENDGBL - Glass Baluster Level - 5 per box

ENDGBS - Glass Baluster Stair - 5 per box

#### NOTE:

When ordering Glass Baluster Kits, balusters are ordered separately. If using ENDGBL (above) your finished rail height will be 39<sup>5/8</sup>". See below for baluster quantity requirements by kit length:

#### For Level Kits:

Kit Length	# Balusters
4 ft	6
5 ft	8
6 ft	9
8 ft	12
10 ft	15

#### For Stair Kits:

Kit Length	# Balusters
6 ft 29°-35°	7
6 ft 36°-41°	7
8 ft 29°-35°	10
8 ft 36°-41°	9

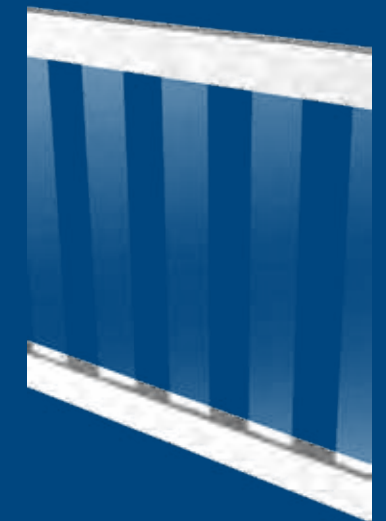

†Includes EASB Level Rail Support.



## STEP 3 - PICK A KIT

# PORCH RAIL LEVEL & STAIR KITS

Porch Rail adds a new dimension to railing design. With multiple top cover, baluster, and accessory options, you can choose the style that compliments your style. Railing kits contain everything you need to create a safe and code-compliant rail section in one convenient box. Level kits come in 6 and 8ft. lengths; stair kits come in 6 and 8ft. lengths and angles of either 29°-35° or 36°-41° (eliminating cutting or filling baluster holes). All kits are available in your choice of balusters: square, turned, round metal, glass, & belly. (See pages 43-47 for details).



## STEP 3 - PICK A KIT

# KIT OPTIONS

### SQUARE BALUSTER RAIL KITS (Balusters included in kit box.)

#### LEVEL 36" HEIGHT - SMOOTH TOP

EPRL6 - 6' lgth. smooth top

EPRL8 - 8' lgth. smooth top

#### LEVEL 42" HEIGHT - SMOOTH TOP

EPRL642 - 6' lgth. smooth top

EPRL842 - 8' lgth. smooth top

#### STAIR 36" HEIGHT SMOOTH TOP

EPRS629 - 6' lgth. - 29°-35° smooth top

EPRS636 - 6' lgth. - 36°-41° smooth top

EPRS829 - 8' lgth. - 29°-35° smooth top

EPRS836 - 8' lgth. - 36°-41° smooth top

#### STAIR 42" HEIGHT - SMOOTH TOP

EPRS62942 - 6' lgth. - 29°-35° smooth top

EPRS63642 - 6' lgth. - 36°-41° smooth top

EPRS82942 - 8' lgth. - 29°-35° smooth top

EPRS83642 - 8' lgth. - 36°-41° smooth top

#### LEVEL 36" HEIGHT - TEXTURED TOP

EPRL6B - 6' lgth. textured top

EPRL8B - 8' lgth. textured top

#### LEVEL 42" HEIGHT - TEXTURED TOP

EPRL642B - 6' lgth. textured top

EPRL842B - 8' lgth. textured top

#### STAIR 36" HEIGHT - TEXTURED TOP

EPRS629B - 6' lgth. - 29°-35° textured top

EPRS636B - 6' lgth. - 36°-41° textured top

EPRS829B - 8' lgth. - 29°-35° textured top

EPRS836B - 8' lgth. - 36°-41° textured top

#### STAIR 42" HEIGHT - TEXTURED TOP

EPRS62942B - 6' lgth. - 29°-35° textured top

EPRS63642B - 6' lgth. - 36°-41° textured top

EPRS82942B - 8' lgth. - 29°-35° textured top

EPRS83642B - 8' lgth. - 36°-41° textured top

#### LEVEL 36" HEIGHT - WOOD TOP\*

EPRL6WD - 6' lgth. wood top

EPRL8WD - 8' lgth. wood top

#### LEVEL 42" HEIGHT - WOOD TOP

EPRL642WD - 6' lgth. wood top

EPRL842WD - 8' lgth. wood top

#### STAIR 36" HEIGHT - WOOD TOP

EPRS629WD - 6' lgth. - 29°-35° wood top

EPRL636WD - 6' lgth. - 36°-41° wood top

EPRS829WD - 8' lgth. - 29°-35° wood top

EPRS836WD - 8' lgth. - 36°-41° wood top

#### STAIR 42" HEIGHT - WOOD TOP

EPRS62942WD - 6' lgth. - 29°-35° wood top

EPRS63642WD - 6' lgth. - 36°-41° wood top

EPRS82942WD - 8' lgth. - 29°-35° wood top

EPRS83642WD - 8' lgth. - 36°-41° wood top

EPRWTC6 - 6' lgth. custom wood top

EPRWTC8 - 8' lgth. custom wood top

Smooth Top



Textured Top (for painting)



Custom Wood Top



Use the Stair Kit Ordering Guide on page 29 to determine the correct stair kit for your installation.

\*Wood Top shown above must be ordered separately. Lead times vary based on wood species.

# STEP 3 - PICK A KIT

## KIT OPTIONS

### TURNED BALUSTER RAIL KITS (Balusters included in kit box.)

#### LEVEL 36" HEIGHT - SMOOTH TOP

EPRTL6 - 6' lgth. smooth top  
EPRTL8 - 8' lgth. smooth top

#### STAIR 36" HEIGHT SMOOTH TOP

EPRTS629 - 6' lgth. - 29°-35° smooth top  
EPRTS636 - 6' lgth. - 36°-41° smooth top  
EPRTS829 - 8' lgth. - 29°-35° smooth top  
EPRTS836 - 8' lgth. - 36°-41° smooth top

#### LEVEL 36" HEIGHT - TEXTURED TOP

EPRTL6B - 6' lgth. textured top  
EPRTL8B - 8' lgth. textured top

#### STAIR 36" HEIGHT - TEXTURED TOP

EPRTS629B - 6' lgth. - 29°-35° textured top  
EPRTS636B - 6' lgth. - 36°-41° textured top  
EPRTS829B - 8' lgth. - 29°-35° textured top  
EPRTS836B - 8' lgth. - 36°-41° textured top

#### LEVEL 36" HEIGHT - WOOD TOP\*

EPRTL6WD - 6' lgth. wood top  
EPRTL8WD - 8' lgth. wood top

#### STAIR 36" HEIGHT - WOOD TOP

EPRTS629WD - 6' lgth. - 29°-35° wood top  
EPRTS636WD - 6' lgth. - 36°-41° wood top  
EPRTS829WD - 8' lgth. - 29°-35° wood top  
EPRTS836WD - 8' lgth. - 36°-41° wood top

EPRWTC6 - 6' lgth. custom wood top  
EPRWTC8 - 8' lgth. custom wood top

Smooth Top



Textured Top (for painting)

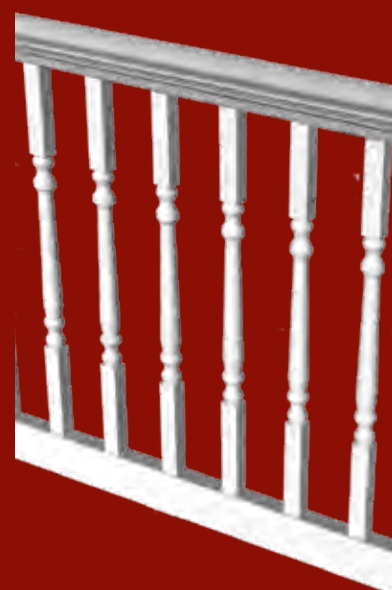

Custom Wood Top

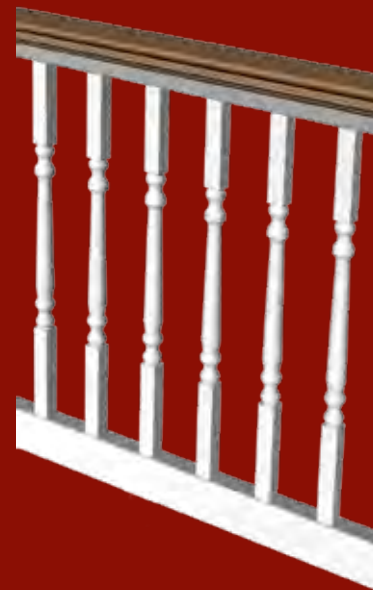

\*Wood Top shown above must be ordered separately. Lead times vary based on wood species.

# STEP 3 - PICK A KIT

## KIT OPTIONS

### ROUND BALUSTER RAIL KITS (Balusters included in kit box.)

#### LEVEL 36" HEIGHT - SMOOTH TOP

EPRRL6 - 6' lgth. smooth top  
EPRRL8 - 8' lgth. smooth top

#### STAIR 36" HEIGHT SMOOTH TOP

EPRRS629 - 6' lgth. - 29°-35° smooth top  
EPRRS636 - 6' lgth. - 36°-41° smooth top  
EPRRS829 - 8' lgth. - 29°-35° smooth top  
EPRRS836 - 8' lgth. - 36°-41° smooth top

#### LEVEL 36" HEIGHT - TEXTURED TOP

EPRRL6B - 6' lgth. textured top  
EPRRL8B - 8' lgth. textured top

#### STAIR 36" HEIGHT - TEXTURED TOP

EPRRS629B - 6' lgth. - 29°-35° textured top  
EPRRS636B - 6' lgth. - 36°-41° textured top  
EPRRS829B - 8' lgth. - 29°-35° textured top  
EPRRS836B - 8' lgth. - 36°-41° textured top

#### LEVEL 36" HEIGHT - WOOD TOP\*

EPRRL6WD - 6' lgth. wood top  
EPRRL8WD - 8' lgth. wood top

#### STAIR 36" HEIGHT - WOOD TOP

EPRRS629WD - 6' lgth. - 29°-35° wood top  
EPRRS636WD - 6' lgth. - 36°-41° wood top  
EPRRS829WD - 8' lgth. - 29°-35° wood top  
EPRRS836WD - 8' lgth. - 36°-41° wood top

EPRWTC6 - 6' lgth. custom wood top  
EPRWTC8 - 8' lgth. custom wood top

Smooth Top

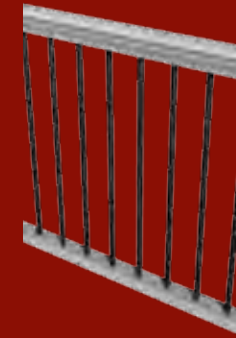

Textured Top (for painting)

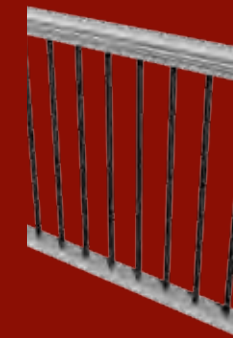

Custom Wood Top



### ROUND BALUSTER RAIL KITS

(Balusters NOT included. Refer to chart on page 39 for quantity requirements for each kit.)

#### LEVEL 36" HEIGHT - SMOOTH TOP

EPRL6RD - 6' lgth. smooth top  
EPRL8RD - 8' lgth. smooth top

#### STAIR 36" HEIGHT SMOOTH TOP

EPRS629RD - 6' lgth. - 29°-35° smooth top  
EPRS636RD - 6' lgth. - 36°-41° smooth top  
EPRS829RD - 8' lgth. - 29°-35° smooth top  
EPRS836RD - 8' lgth. - 36°-41° smooth top

#### LEVEL 36" HEIGHT - TEXTURED TOP

EPRL6BRD - 6' lgth. textured top  
EPRL8BRD - 8' lgth. textured top

#### STAIR 36" HEIGHT - TEXTURED TOP

EPRS629BRD - 6' lgth. - 29°-35° textured top  
EPRS636BRD - 6' lgth. - 36°-41° textured top  
EPRS829BRD - 8' lgth. - 29°-35° textured top  
EPRS836BRD - 8' lgth. - 36°-41° textured top

#### LEVEL 36" HEIGHT - WOOD TOP\*

EPRL6WRD - 6' lgth. wood top  
EPRL8WRD - 8' lgth. wood top

#### STAIR 36" HEIGHT - WOOD TOP

EPRS629WRD - 6' lgth. - 29°-35° wood top  
EPRS636WRD - 6' lgth. - 36°-41° wood top  
EPRS829WRD - 8' lgth. - 29°-35° wood top  
EPRS836WRD - 8' lgth. - 36°-41° wood top

#### ROUND METAL BALUSTER - 10 Per Box

MWAB32B - Aluminum Baluster - Black

#### SLIDERS - 4 Per Set

MWAS3402B - Short Aluminum Slider - Black  
MWAS3406B - Tall Aluminum Slider - Black

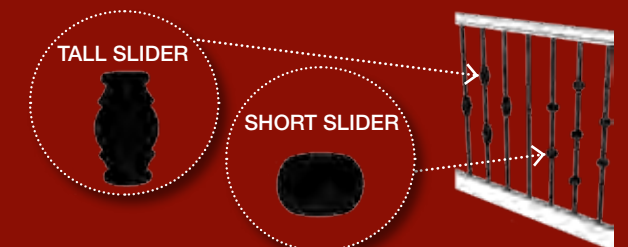

\*Wood Top shown above must be ordered separately. Lead times vary based on wood species.

# STEP 3 - PICK A KIT

## KIT OPTIONS

### GLASS BALUSTER RAIL KITS (Balusters not included in kit box.)

#### LEVEL KITS - SMOOTH TOP

EPRL6GS - 6' lgth. smooth top

EPRL8GS - 8' lgth. smooth top

#### STAIR KITS - SMOOTH TOP

EPRS629GS - 6' lgth. - 29°-35° smooth top

EPRS636GS - 6' lgth. - 36°-41° smooth top

EPRS829GS - 8' lgth. - 29°-35° smooth top

EPRS836GS - 8' lgth. - 36°-41° smooth top

#### LEVEL KITS - TEXTURED TOP

EPRL6BGS - 6' lgth. textured top

EPRL8BGS - 8' lgth. textured top

#### STAIR KITS - TEXTURED TOP

EPRS629BGS - 6' lgth. - 29°-35° textured top

EPRS636BGS - 6' lgth. - 36°-41° textured top

EPRS829BGS - 8' lgth. - 29°-35° textured top

EPRS836BGS - 8' lgth. - 36°-41° textured top

#### LEVEL KITS - WOOD TOP\*

EPRL6WDGS - 6' lgth. wood top

EPRL8WDGS - 8' lgth. wood top

#### STAIR KITS - WOOD TOP

EPRS629WDGS - 6' lgth. - 29°-35° wood top

EPRS636WDGS - 6' lgth. - 36°-41° wood top

EPRS829WDGS - 8' lgth. - 29°-35° wood top

EPRS836WDGS - 8' lgth. - 36°-41° wood top

EPRWTC6 - 6' lgth. custom wood top

EPRWTC8 - 8' lgth. custom wood top

Smooth Top

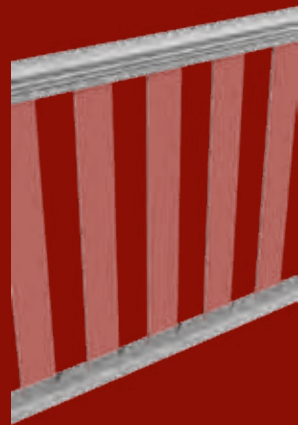

Textured Top (for painting)



Custom Wood Top



Note: When ordering Glass Baluster Kits, balusters are ordered separately. If using ENDGBL (below right) your finished rail height will be 38". See below for baluster quantity requirements by kit length: packaged 5 per box. See below for baluster quantities based on kit length:

#### For Level Kits:

Kit Length	# Balusters
6 ft	9
8 ft	13

#### For Stair Kits:

Kit Length	# Balusters
6 ft 29°-35°	7
6 ft 36°-41°	7
8 ft 29°-35°	10
8 ft 36°-41°	10

#### GLASS BALUSTERS - 5 Per Box

ENDGBL - Glass Balusters for Level Kits

ENDGBS - Glass Balusters for Stair Kits

\*Wood Top shown above must be ordered separately. Lead times vary based on wood species.

# STEP 3 - PICK A KIT

## KIT OPTIONS

### BELLY BALUSTER RAIL KITS (Balusters not included in kit box.)

#### LEVEL 36" HEIGHT - SMOOTH TOP

EPRL6BY - 6' lgth. smooth top

EPRL8BY - 8' lgth. smooth top

#### STAIR 36" HEIGHT SMOOTH TOP

EPRS629BY - 6' lgth. - 29°-35° smooth top

EPRS636BY - 6' lgth. - 36°-41° smooth top

EPRS829BY - 8' lgth. - 29°-35° smooth top

EPRS836BY - 8' lgth. - 36°-41° smooth top

#### LEVEL 36" HEIGHT - TEXTURED TOP

EPRL6BBY - 6' lgth. textured top

EPRL8BBY - 8' lgth. textured top

#### STAIR 36" HEIGHT - TEXTURED TOP

EPRS629BBY - 6' lgth. - 29°-35° textured top

EPRS636BBY - 6' lgth. - 36°-41° textured top

EPRS829BBY - 8' lgth. - 29°-35° textured top

EPRS836BBY - 8' lgth. - 36°-41° textured top

#### LEVEL 36" HEIGHT - WOOD TOP\*

EPRL6WDBY - 6' lgth. wood top

EPRL8WDBY - 8' lgth. wood top

#### STAIR 36" HEIGHT - WOOD TOP

EPRS629WDBY - 6' lgth. - 29°-35° wood top

EPRS636WDBY - 6' lgth. - 36°-41° wood top

EPRS829WDBY - 8' lgth. - 29°-35° wood top

EPRS836WDBY - 8' lgth. - 36°-41° wood top

EPRWTC6 - 6' lgth. custom wood top

EPRWTC8 - 8' lgth. custom wood top

Smooth Top

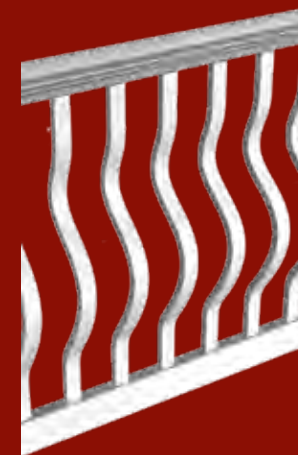

Textured Top (for painting)

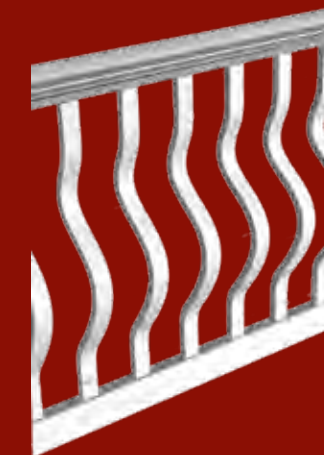

Custom Wood Top



Balusters are packaged 10 per box. See below for baluster quantities based on kit length:

#### For Level Kits:

Kit Length	# Balusters
6 ft	13
8 ft	18

#### For Stair Kits:

Kit Length	# Balusters
6 ft 29°-35°	11
6 ft 36°-41°	10
8 ft 29°-35°	14
8 ft 36°-41°	13

#### BELLY BALUSTERS - 10 Per Box

ENDBBW - Belly Baluster

\*Wood Top shown above must be ordered separately. Lead times vary based on wood species.

## STEP 3 - PICK A KIT

# TITAN PRO RAIL LEVEL & STAIR KITS

Titan Pro and Titan Pro XL kits contain top and bottom vinyl extrusions with internal aluminum stiffeners and square balusters. Level kits come in 6', 8', and 10' lengths, stair kits are offered in 6' or 8', and all are available in either 36" or 42" heights. Posts, brackets, caps, and trim rings are sold separately. Titan meets the International Residential Code (IRC) for hand rail, so no secondary hand rail is required on residential installations (check your code enforcement office for applicability). Stair rail kits are engineered to accommodate stair angles from 32°-38°. Titan Pro posts include pre-attached level brackets. Titan Pro rail kits do not include brackets.



LEVEL 36" RAIL HEIGHT	LEVEL 42" RAIL HEIGHT
TPL6-36 - 6' lgth.	TPL6-42 - 6' lgth.
TPL8-36 - 8' lgth.	TPL8-42 - 8' lgth.
TPL10-36 - 10' lgth.	TPL10-42 - 10' lgth.

STAIR 36" RAIL HEIGHT	STAIR 42" RAIL HEIGHT
TPS6-36 - 6' lgth. 32°-38°	TPS6-42 - 6' lgth. 32°-38°
TPS8-36 - 8' lgth. 32°-38°	TPS8-42 - 8' lgth. 32°-38°



EASB two-piece level rail support (2"), included in all Titan Pro rail level kits and also sold separately.

### TITAN PRO XL

Titan Pro XL is Titan Pro with a bit more brawn. Profiles of both Titan systems are the same, although the balusters of Titan Pro XL are 1 1/4" as opposed to 1".

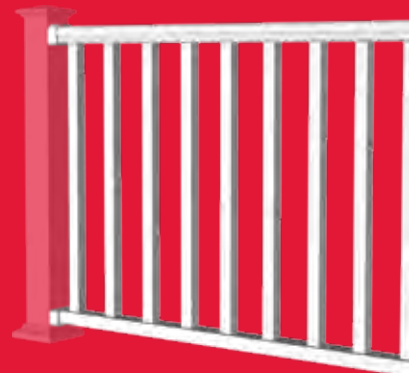

LEVEL 36" RAIL HEIGHT	LEVEL 42" RAIL HEIGHT
TPL6-36XL - 6' lgth.	TPL6-42XL - 6' lgth.
TPL8-36XL - 8' lgth.	TPL8-42XL - 8' lgth.
TPL10-36XL - 10' lgth.	TPL10-42XL - 10' lgth.

STAIR 36" RAIL HEIGHT	STAIR 42" RAIL HEIGHT
TPS6-36XL - 6' lgth. 32°-38°	TPS6-42XL - 6' lgth. 32°-38°
TPS8-36XL - 8' lgth. 32°-38°	TPS8-42XL - 8' lgth. 32°-38°



## STEP 3 - PICK A KIT

# Excalibur RAIL PANELS & CUSTOM WOOD TOP

Metal Works Excalibur panels are pre-assembled and ready for fast, simple installation. All rail panels are available in 2 heights.\* Stair panels are fully hinged to allow installation on virtually any stair angle, down to a 5 degree handicap accessible ramp. If using Excalibur Posts, level brackets are pre-attached to the posts; for all other level and stair applications, brackets must be purchased separately. Custom Wood Top Covers must be ordered separately from railing kits.

### CUSTOM WOOD TOP and BRACKETS

MWEWTC6 - 6' lgth. wood top
MWEWTC8 - 8' lgth. wood top
MWEWTC10 - 10' lgth. wood top
MWEWCB4 - wood top mounting brackets (set of 4)

LEVEL 34" PANEL	LEVEL 40" PANEL
MWEL6-36B - 6' lgth.	MWEL6-42B - 6' lgth.
MWEL8-36B - 8' lgth.	MWEL8-42B - 8' lgth.
MWEL10-36B - 10' lgth.	MWEL10-42B - 10' lgth.



STAIR 34" PANEL	STAIR 40" PANEL
MWES6-36B - 6' lgth.	MWES6-42B - 6' lgth.
MWES8-36B - 8' lgth.	MWES8-42B - 8' lgth.

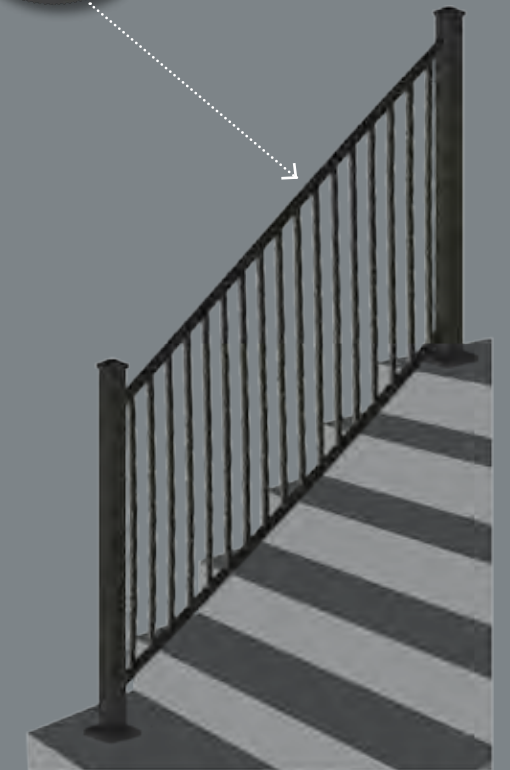

\*When using Excalibur posts, 34" high level rail panels will install to a 36 inch finished height with a 2 inch bottom space or 38 inch finished height with a 4 inch bottom space. Excalibur 40" high level rail panels will install to a 42 inch finished height with a 2 inch bottom space or 44 inch finished height with a 4 inch bottom space. Refer to page 34 for more information.

Factory matched touch-up paint (MWETPB) is available through your RDI Dealer.

# STEP 4 - PICK YOUR BRACKET KITS

## ORIGINAL RAIL BRACKETS

All Endurance Original and Deck Rail kits come complete with brackets and all necessary hardware. Level and stair bracket kits are also sold separately to split one rail kit into 2 complete sections. Other bracket kits are available allowing simple installation of some common custom applications.

- LEVEL BRACKET KIT - EALB2 - 2 top, 2 bottom
- STAIR BRACKET KIT - EASB2 - 2 top, 2 bottom
- ROUND COLUMN BRACKET KIT - EARB1 - 1 top, 1 bottom
- 45° ANGLE BRACKET KIT - EAAK45 - 1 top, 1 bottom
- 0-44° ANGLE BRACKET KIT - EAAK1 - 1 top, 1 bottom
- PAINTABLE ROUND COLUMN ADAPTER KIT - EARCA - 1 top, 1 bottom

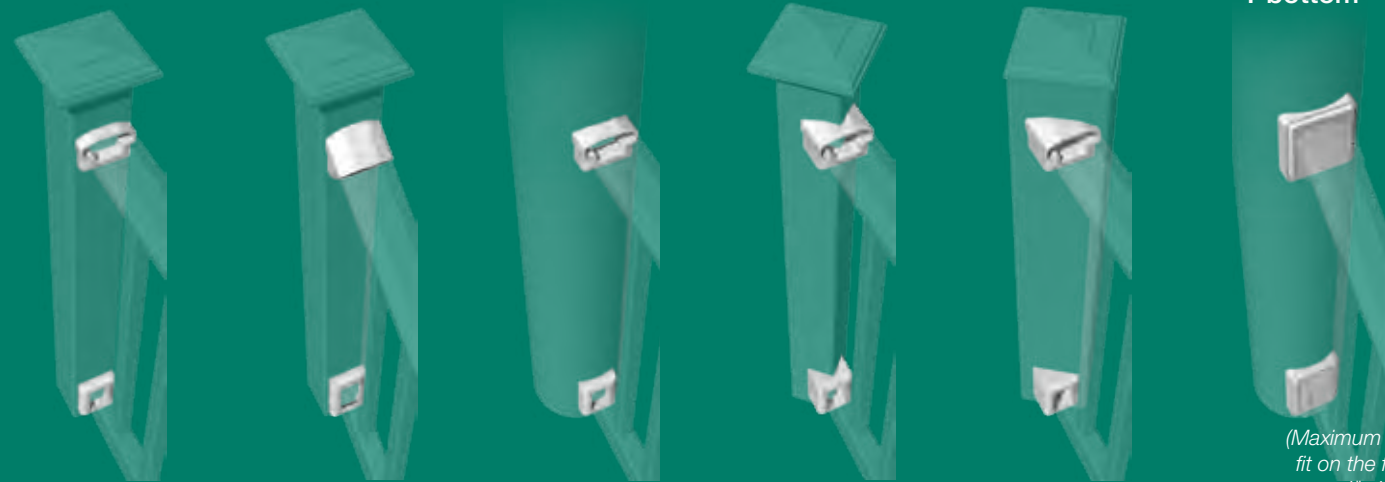

(Maximum angle to fit on the face of a 4"x4" is 32°.)

## DECK RAIL BRACKETS

- LEVEL BRACKET KIT - EDALB2 - 2 top, 2 bottom
- STAIR BRACKET KIT - EDASB2 - 2 top, 2 bottom
- ROUND COLUMN BRACKET KIT - EDARB1 - 1 top, 1 bottom
- 45° ANGLE BRACKET KIT - EDAAK45 - 1 top, 1 bottom
- 0-44° ANGLE BRACKET KIT - EDAAK1 - 1 top, 1 bottom
- PAINTABLE ROUND COLUMN ADAPTER KIT - EDARCA - 1 top, 1 bottom

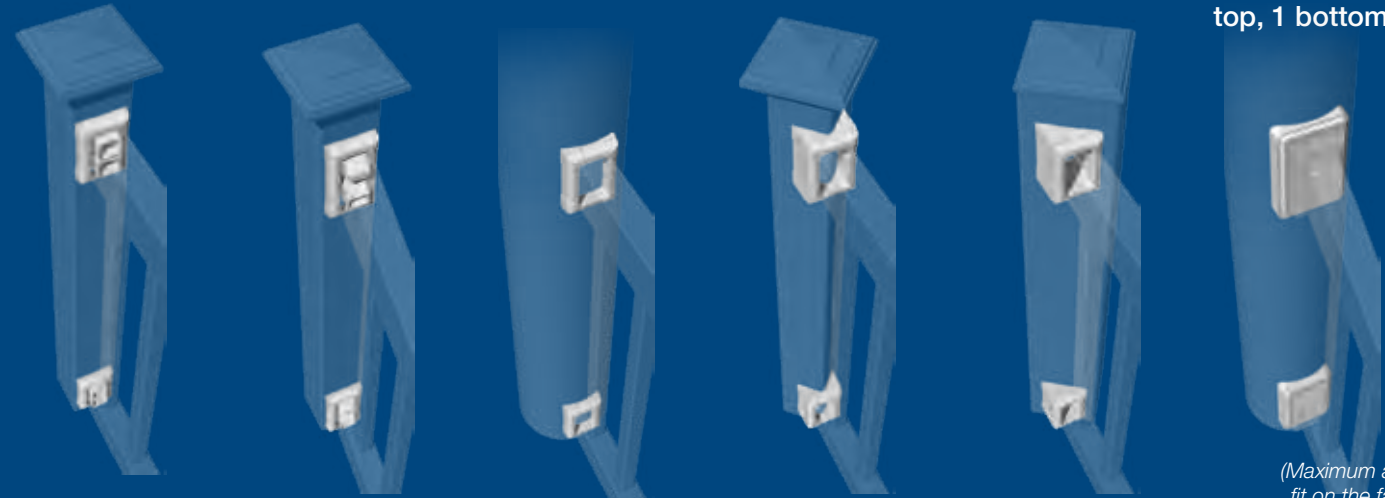

(Maximum angle to fit on the face of a 4"x4" is 32°.)

# STEP 4 - PICK YOUR BRACKET KITS

## PORCH RAIL BRACKETS

All Endurance rail kits come complete with brackets. Level and stair bracket kits are also sold separately to split one rail kit into 2 complete sections. Other bracket kits are available allowing simple installation of some common custom applications. All brackets and fasteners are hidden from view; no additional covers are necessary.

- LEVEL BRACKET KIT - EPRALBK - 2 top, 2 bottom with hardware
- STAIR BRACKET KIT - EPRASBK - 2 top, 2 bottom with hardware
- ROUND COLUMN ADAPTER - EPRARCA - 1 top, 1 bottom



## SO...what's this all about?

Were you paying attention or did we create this whole brochure for nothing? Let's find out! One of the people in the below photo appears on an additional page in this brochure. Your mission is to browse the brochure and locate and identify this RDI employee. Then, go to [www.rdirail.com](http://www.rdirail.com) (hint- see the "About Us" page) and click the "Live Help" link and tell us on what page you saw our RDI employee and who he or she is. If you're right, there is a surprise in store for you!!



# STEP 4 - PICK YOUR BRACKETS

## TITAN PRO BRACKETS

Titan Pro posts come complete with pre-attached level brackets; Titan Pro rail kits do not include brackets. Level and Stair Bracket kits can be used to install Titan Pro railing to existing posts, walls, or other mounting surfaces and come complete with everything necessary to install one railing section.

### TPABKL - LEVEL BRACKET KIT

**LEVEL BRACKET - 2**  
top, 2 bottom and hardware



**TOP LEVEL BRACKET COVER - 2**



**BOTTOM LEVEL BRACKET COVER - 2**



### TPABKS - STAIR BRACKET KIT

**TOP STAIR BRACKET - 2 with hardware**



**TOP STAIR BRACKET COVER - 2**



**BOTTOM STAIR BRACKET - 2 with hardware**



**BOTTOM STAIR BRACKET COVER - 2**



**45° BRACKET ADAPTER KIT - TPA45AK -**  
allows rail attachment at 45° - 1 top, 1 bottom



**22.5° BRACKET ADAPTER KIT - TPA22AK -**  
allows rail attachment at 22.5° - 1 top, 1 bottom



**ROUND COLUMN BRACKET ADAPTER KIT - TPARCA -**  
allows attachment to round columns - 1 top, 1 bottom



# STEP 4 - PICK YOUR BRACKETS

## EXCALIBUR BRACKETS

Excalibur posts come complete with pre-attached level brackets. Level and Stair Bracket Kits can be used to install Excalibur railing to existing posts, walls, or other mounting surfaces and come complete with everything necessary to install one rail panel. Angle Bracket Kit allows attachment at virtually any angle. To attach a custom wood or composite top cover to Excalibur, Top Cap Bracket Kit is offered.

### MWEABKLB - LEVEL BRACKET KIT

**LEVEL BRACKET - 2 top, 2 bottom & hardware**



**LEVEL BRACKET COVER - 2 top, 2 bottom**

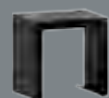

### MWEABKSB - STAIR/LEVEL ANGLE BRACKET KIT

**2 top, 2 bottom & hardware**

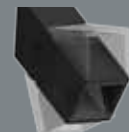

### MWEWCB4 - TOP CAP BRACKET KIT

**4 brackets & hardware**

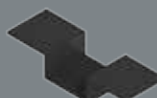

Note - Screws supplied with Excalibur brackets are only to be used when mounting to Excalibur posts. When mounting to other surfaces use fasteners designed for the type of mounting surface will meet the prescribed building code design loads.

# STEP 5 - PICK A GATE KIT

## GATE KITS

Endurance, Titan Pro, and Excalibur gates are available in both 36" or 42" rail heights and are manufactured to fit a 36" wide finished opening. Both Endurance and Titan gates can be special ordered to fit openings as wide as 98". Excalibur offers gate kits that allow on-site fabrication in custom widths using a level rail panel. Don't worry; understanding this page is more difficult than the gates themselves!



**CROSSOVER AND TITAN GATE KIT**



**ORIGINAL RAIL AND PORCH RAIL TURNED BALUSTER GATE KIT**

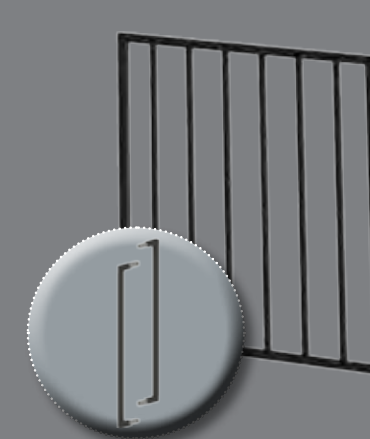

**EXCALIBUR GATE AND CUSTOM GATE KIT**

EAG36	36" Ht Gate - matches all Endurance Rail (square balusters) & Titan Pro XL
EACG36	42" Ht Gate - matches Original, Porch Rail (square balusters) & Titan Pro XL
EAGS01	36" Ht Custom Gate - matches all Endurance Rail (square balusters) & Titan Pro XL; 48" max width
EAGS03	42" Ht Custom Gate - matches Original & Porch Rail (square balusters) & Titan Pro XL 48" max width
EATG36	36" Ht Gate - matches Original & Porch Rail (turned balusters)
EAGSO2	36" Ht Custom Gate - matches Original & Porch Rail (turned balusters); 48" max width
EDATG36	36" Ht Deck Rail Standard Gate - (turned balusters)
EDAGSO4	36" Ht Deck Rail Custom Gate - (turned balusters); 48" maximum width
TPAG36	36" Ht Titan Pro Rail Gate (square balusters)
TPACG36	42" Ht Titan Pro Rail Gate (square balusters)
TPAGSO	36" Ht Titan Pro Rail Custom Gate (square balusters); 48" maximum width
TPACGSO	42" Ht Titan Pro Rail Custom Gate (square balusters); 48" maximum width
EFAGH201W	Gate Hardware Kit - 2 self-closing hinges, 1 locking latch, white
EFAGH201B	Gate Hardware Kit - 2 self-closing hinges, 1 locking latch, black
EAHPW	Hinge Pair - No Latch - white - Required for Double Gate Installation
EAHPB	Hinge Pair - No Latch - black - Required for Double Gate Installation
EASC6	Screw Button Covers - pack of 6
MWEG36B	36" Ht Excalibur Assembled Gate, black
MWEG42B	42" Ht Excalibur Assembled Gate, black
MWEGK36B	36" Ht Excalibur Gate Kit (requires level rail panel to complete), black
MWEGK42B	42" Ht Excalibur Gate Kit (requires level rail panel to complete), black
MWEAGHB	Metal Works Gate Hardware Kit - 2 self-closing hinges, 1 locking latch, black
MWEAHB	Metal Works Gate Hinge - 2 hinges, no latch, black

# STEP 6 - SECONDARY HAND RAIL

## HAND RAIL COMPONENTS

The Endurance vinyl clad aluminum Hand Rail System can be joined in any configuration to provide ADA-compliant graspability on stairs or ramps. The vinyl components are easily linked to aluminum-reinforced vinyl rails with straight and adjustable aluminum joiners. The system can be installed on-site and mounted to any wall surface or railing material: vinyl, wood, or steel.

### 180° RETURN LOOP

Returns the rail back past the post center line to meet ADA graspability requirements.



HRHLW - 180 degree return loop - white  
HRHLB - 180 degree return loop - black

### HAND RAIL LINEAL

1½" diameter vinyl-clad aluminum Hand Rail Lineals are engineered to add strength and rigidity to the entire installation.



HR80W	80" lgth - white
HR80B	80" lgth - black
HR104W	104" lgth - white
HR104B	104" lgth - black
HR120W	120" lgth - white
HRH120B	120" lgth - black

### 90° CORNER

Powder-coated cast aluminum 90°Corner is used wherever you need a 90° bend. Eliminates miter cuts and speeds installation. Includes two 3" joiners.



HRCNW - 90 degree corner - white  
HRCNB - 90 degree corner - black

### HAND RAIL BRACKETS

Powder-coated cast aluminum Hand Rail Brackets are designed for increased strength and easy installation to any surface (6' maximum span between brackets). Includes stainless steel screws and mounting bolt cover (mounting bolt not included).



HRBW - mounting bracket - white  
HRBB - mounting bracket - black

# STEP 6 - SECONDARY HAND RAIL

## INSERTS & RETURNS

### STRAIGHT RETURN

Cast aluminum Straight Return terminates railing to any wall or post. Includes our unique snap-fit design vinyl cover plate to conceal fasteners.



HRSRW - straight return - white  
HRSRB - straight return - black

### 90° POST RETURN

Powder-coated cast aluminum 90°Post Return creates a smooth termination at any post or wall. Includes a 3" aluminum joiner and our unique snap-fit design vinyl cover plate to conceal fasteners.



HRPRW - 90 degree post return - white  
HRPRB - 90 degree post return - black

### END CAPS

1½" Diameter Vinyl End Caps are adhered into the end of the railing to give a sleek, finished look.



HRECW - end cap - white  
HRECB - end cap - black

### JOINT RING

Vinyl Joint Ring conceals joints in the lineals, giving a seamless appearance



HRJRW - joint ring - white  
HRJRB - joint ring - black

### INSIDE CORNER BRACKET

Powder-coated aluminum Inside Corner Brackets allow secure attachment of Hand Rail to post corners at a 45° angle. Includes stainless steel screws and mounting bolt covers (mounting bolts not included).



HRICBW - inside corner bracket - white  
HRICBB - inside corner bracket - black

### STRAIGHT AND ADJUSTABLE INTERNAL JOINERS

Aluminum Straight and Adjustable Joiners provide continuous, uninterrupted, metal-to-metal connections at all angles and joints and easily glue in place. Adjustable Joiner accommodates angles up to 90°.

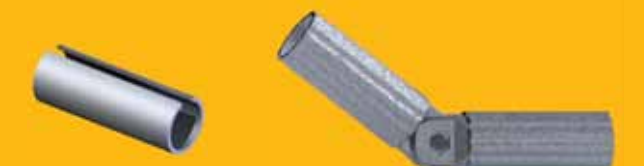

HRSJ - straight joiner

HRAJ - adjustable joiner

# STEP 6 - SECONDARY HAND RAIL HANDRAIL INSTALLATION

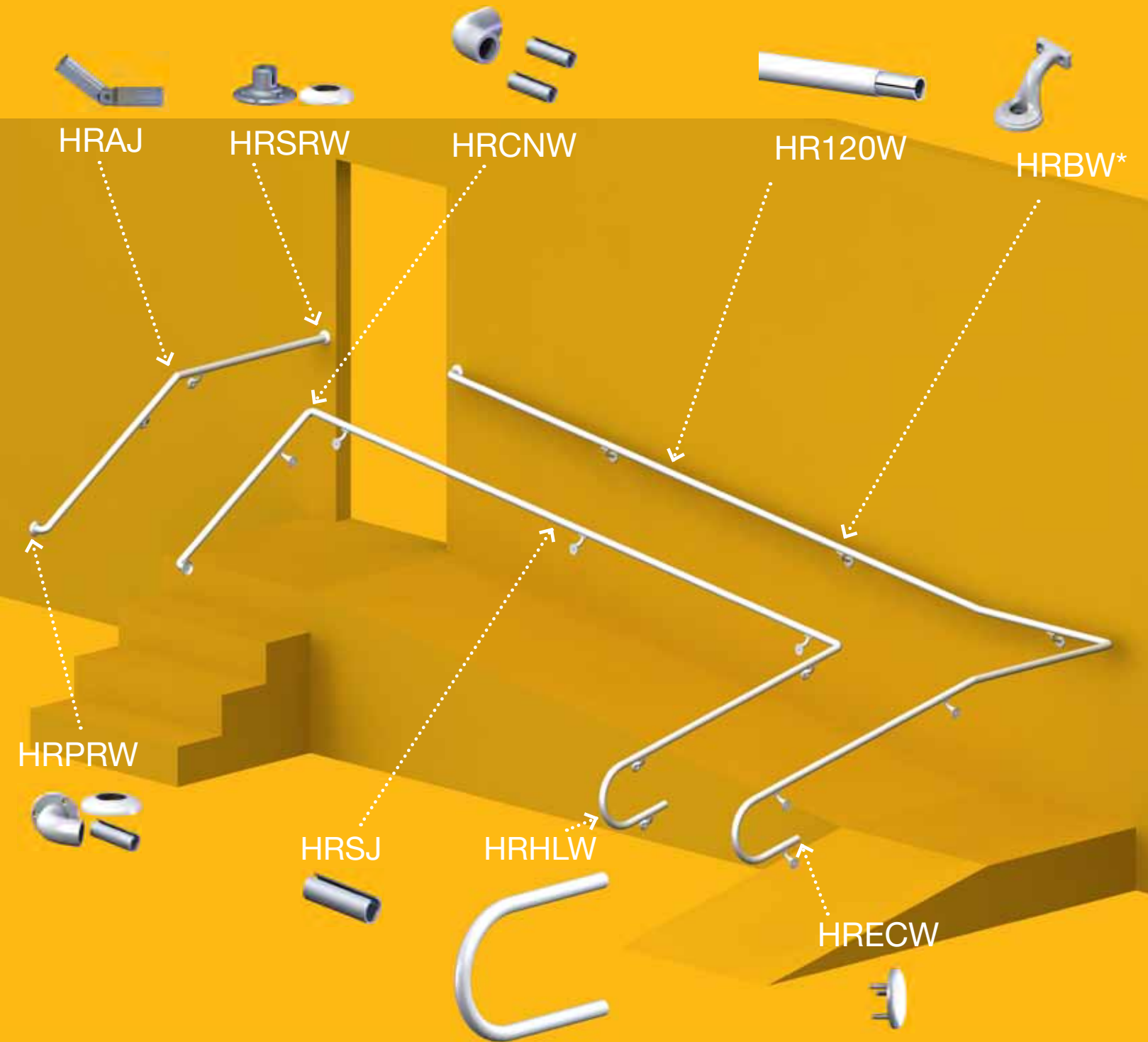

\* Brackets should be placed underneath joint or on both sides of the joint, no more than 6' apart.



## YOU WANT WHAT??!

Thank you... for choosing our products and for taking the time to browse our brochure. We spend countless hours striving to bring you the most complete and versatile quality railing and porch systems in the industry and hope that you have found a system here that meets your needs. If you have something in mind other than the Endurance, Excalibur, and Titan Pro products shown in our brochure, please call us and we will make every effort to accommodate you. At RDI, it's Your Railing, Your Way™, and if we don't make it we will do what we can to provide it for you. Whether it is mixing and matching components across our product families, you need something not shown in our catalog at all, or want something that you think sounds completely crazy. (Of course we WILL try to dissuade you from pumpkin-colored metal balusters with the sea foam green sliders!) Simply give us a call (at 877.420.7245) and we will do our best to come up with a solution to fit your needs.







**rdi**®

**Railing Dynamics, Inc.**

For home, for life.®

135 Steelmanville Road  
Egg Harbor Township, NJ 08234

TEL: (877) 420-7245

FAX: (866) 277-5160

E-MAIL: [cs@rdirail.com](mailto:cs@rdirail.com)

URL: [www.rdirail.com](http://www.rdirail.com)



The Endurance and Titan Pro Systems exceed U.S. building code requirements and have been independently tested by PFS laboratories, a third-party, ICC-ES certified testing and inspection agency. Visit [www.icc-es.org](http://www.icc-es.org) to view testing data, certifications, or to print a report.

Always consult your local Building Code Department for applicable regulations and product acceptance.

For additional information on Endurance or Titan Pro rail and porch products visit [www.rdirail.com](http://www.rdirail.com) or contact our Customer Service Department at (877) 420-7245.

Please note that the color representations in this brochure are not necessarily precise representations of actual material colors due to the variance in the printing process. Please consult an actual sample before making any critical color matching decisions.

*Endurance*®

**TITAN**®  
**PRO RAIL**

**METAL**™  
**WORKS**